

REGULATORS SPECIFICATION FOR BACKFLOW

Approved by the regulators, this is one of three Regulator's Specifications. It provides descriptions defining different forms of backflow prevention and the level as well as type of protection they provide. It does not however set performance requirements; these are detailed in the Regulators Specification for fittings or appropriate British Standard.

Terminology

To aid understanding the specification includes number of definitions for terms which are used.

'An air gap' means a visible, unobstructed and complete physical air break between the lowest level of water discharge and the level of potentially contaminated fluid downstream (critical water level) within a cistern, vessel, fitting or appliance, hereinafter called a receptacle, that:

- a. is not less than 20mm or twice the internal diameter of the inlet pipe whichever is the greater; and
- b. from which water discharges at not more than 15° from the vertical centreline of the water stream.

'Critical level' means the physical or piezometric level of the fluid in any part of the receptacle a minimum of two seconds after closing the water inlet, starting from maximum water level.

'Maximum level' means the highest physical or piezometric level of the fluid reached in any part of the receptacle when operated continuously under fault conditions,

'Spillover level' means the level at which the fluid in a receptacle will first spill over the top edge of a receptacle if the inflow of water exceeds the outflow through any outlet and any overflow pipe.

'Tap gap' means the vertical distance between the lowest part of a tap outlet and the spillover level of the appliance or receptacle over which the tap discharges.

An **'upstand'** means either one of two alternative arrangements of water fittings to prevent backflow by backsiphonage:

Type A upstand. An upward flowing supply or distributing pipe surmounted by an anti-vacuum valve (Type DA), or an anti-vacuum valve combined with a single check valve (Type DUK1), any part of the outlet of which is located not less than 300mm above the spillover level of an appliance.

Type B upstand. A branch pipe serving an appliance, where the height of any part of the branch connection to the vented distributing pipe is not less than 300mm above:

- a. the spillover level of the appliance; or
- b. the highest possible discharge point served by the vented distributing pipe, whichever is the highest.

'A verifiable backflow prevention device' means a device, consisting of one or more backflow prevention elements, which can be tested in-situ; usually achieved by the provision of test ports immediately upstream, and between, the mechanical elements comprising the device.

Descriptions of backflow prevention arrangements and devices

Please note: Overflows and warning pipes shall discharge through, or terminate with, an air gap, the dimension of which should satisfy a Type AA air gap.

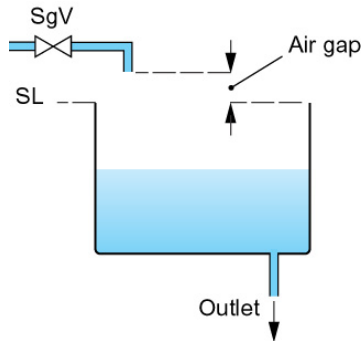

'Type AA – Air gap with unrestricted discharge' means a non-mechanical backflow prevention arrangement of water fittings where water is discharged through an air gap into a receptacle which has at all times an unrestricted spillover to the atmosphere.

Fluid category rating	
Back Pressure	Back Siphonage
5	5

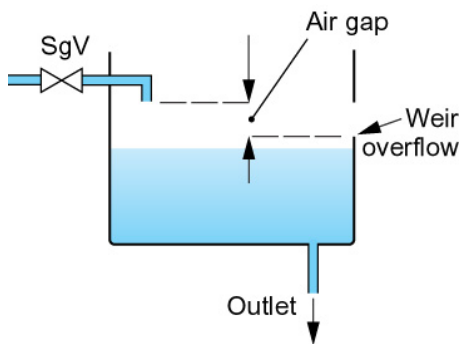

'Type AB – Air gap with weir overflow' means a non-mechanical backflow prevention arrangement of water fittings complying with Type AA, except that the air gap is the vertical distance from the lowest point of the discharge orifice which discharges into the receptacle, to the critical water level of the rectangular weir overflow.

Fluid category rating	
Back Pressure	Back Siphonage
5	5

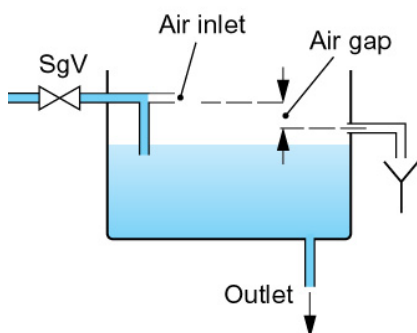

'Type AC – Air gap with vented submerged inlet and circular overflow' means a non-mechanical backflow prevention arrangement of water fittings with a vented, but submerged, inlet; the air gap being measured vertically downwards from the lowest point of the air inlet to the critical level.

Fluid category rating	
Back Pressure	Back Siphonage
3	3

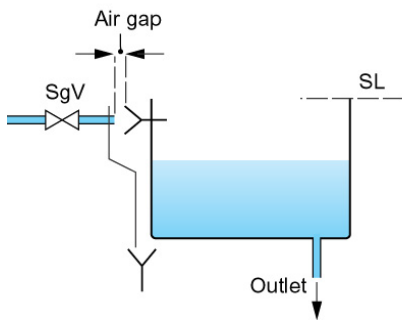

'Type AD – Air gap with injector' means a non-mechanical backflow prevention arrangement of water fittings with a horizontal injector and a physical air gap of 20 millimetres or twice the inlet diameter, whichever is the greater.

Fluid category rating	
Back Pressure	Back Siphonage
5	5

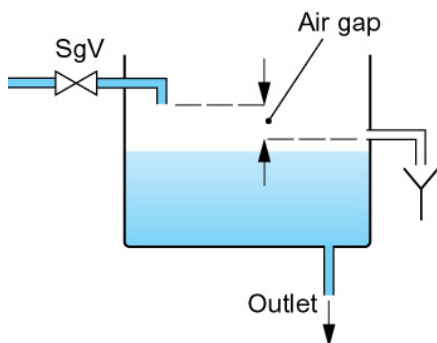

'Type AF – Air gap with circular overflow' means a non-mechanical backflow prevention arrangement of water fittings with an air gap measured downwards from the lowest point of the discharge orifice, which discharges into the receptacle, to the critical level.

Fluid category rating	
Back Pressure	Back Siphonage
4	4

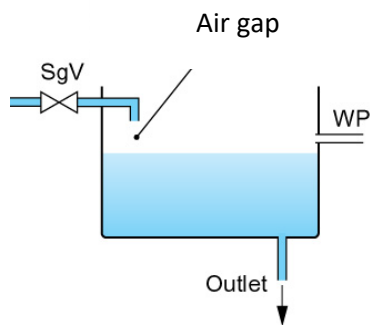

'Type AG – Air gap arrangement with minimum size circular overflow' means a non-mechanical backflow prevention arrangement of water fittings with an air gap; together with an overflow, the size of which is determined by measure or a vacuum test.

Fluid category rating	
Back Pressure	Back Siphonage
3	3

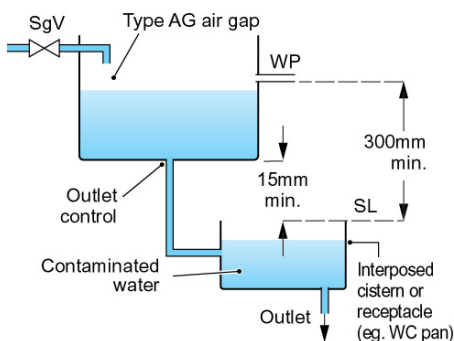

'Type AUK1 – Air gap with interposed cistern' means a non-mechanical backflow prevention arrangement consisting of a cistern with a Type AG overflow and an air gap; the spill-over level of the receiving vessel (WC pan or other receptacle) being located not less than 300 millimetres below the overflow pipe and not less than 15 millimetres below the lowest level of the interposed cistern.

Fluid category rating	
Back Pressure	Back Siphonage
3	5

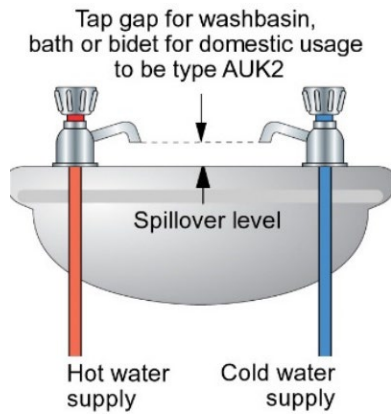

'Type AUK2 – Domestic tap gap' means the height of air gap between the lowest part of the outlet of a tap, combination fitting, shower head or other fitting discharging over a domestic sanitary appliance or other receptacle, and the spillover level of that appliance, where a fluid category 2 or 3 risk is present downstream.

Size of tap or combination fitting	Vertical distance: bottom of tap to spill-over level of receptacle
Not exceeding G ½	20 mm
Exceeding G ½ but not exceeding G ¾	25 mm
Exceeding G ¾	70 mm

Fluid category rating	
Back Pressure	Back Siphonage
X	3

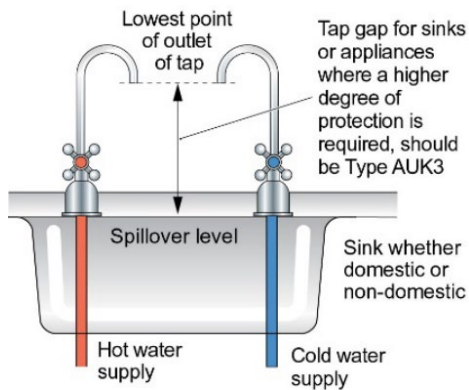

'Type AUK3 – Higher risk tap gap' means the height of an air gap between the lowest part of the outlet of a tap, combination fitting, shower head or other fitting discharging over any appliance or other receptacle, and the spillover level of that appliance, where a fluid category 4 or 5 risk is present downstream.

Fluid category rating	
Back Pressure	Back Siphonage
X	5

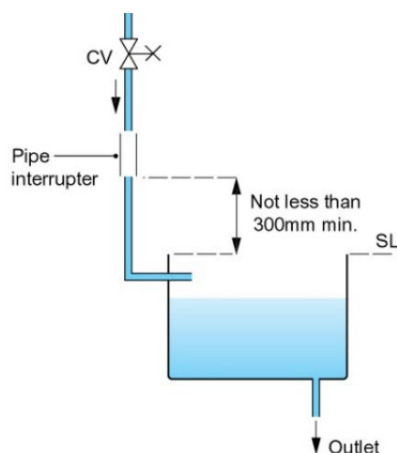

'Type DC – Pipe interrupter with permanent atmospheric vent' means a non-mechanical backflow prevention device with a permanent unrestricted air inlet, the device being installed so that the flow of water is in a vertical downward direction.

Arrangements incorporating Type DC devices shall have no control valves on the outlet of the device; they shall be fitted not less than 300 mm (150 mm in Scotland) above the spillover level of a WC pan, or 150 mm above the sparge pipe outlet of a urinal, and discharge vertically downwards.

Fluid category rating	
Back Pressure	Back Siphonage
X	5

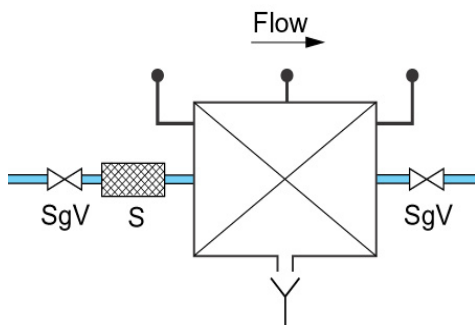
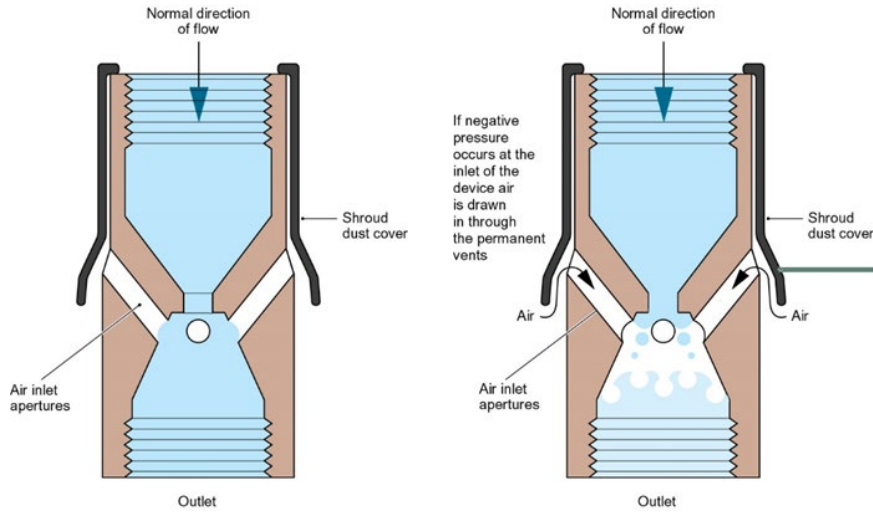

'Type BA – Verifiable backflow preventer with reduced pressure zone' means a verifiable mechanical backflow prevention device consisting of an arrangement of water fittings with three pressure zones with differential obturators and that will operate when potential backflow conditions obtain or there is a malfunction of the valve.

Relief outlet ports from Types BA backflow prevention devices shall terminate with an air gap, the dimension of which should satisfy a Type AA air gap.

Fluid category rating	
Back Pressure	Back Siphonage
4	4

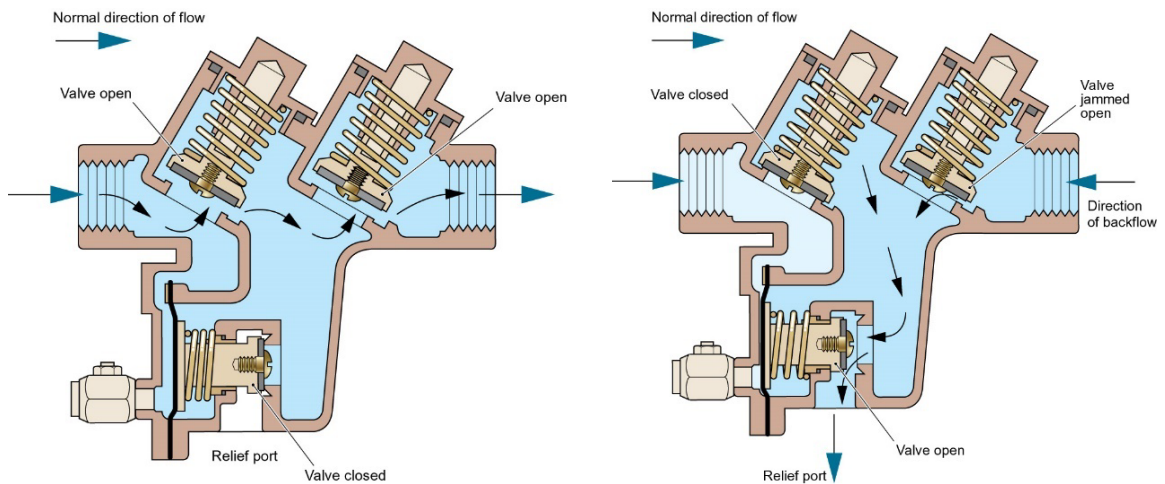

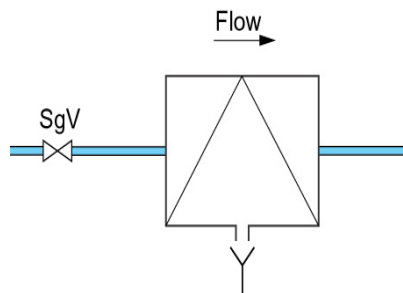

'Type CA – Non-verifiable disconnecter with different pressure zones' means a non-verifiable mechanical backflow prevention device which provides disconnection by venting the intermediate pressure zone of the device to the atmosphere when the difference of pressure between the intermediate zone and the upstream zone is not greater than 10% of the upstream pressure.

Relief outlet ports from Types BA and CA backflow prevention devices shall terminate with an air gap, the dimension of which should satisfy a Type AA air gap.

Fluid category rating	
Back Pressure	Back Siphonage
3	3

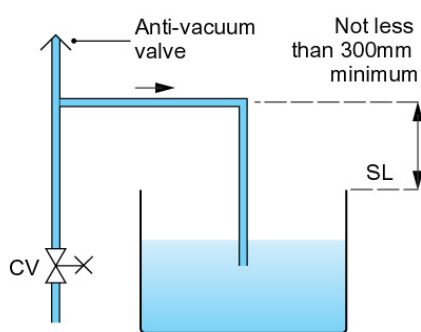
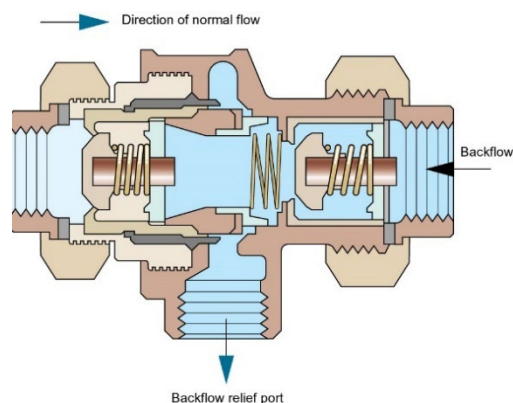
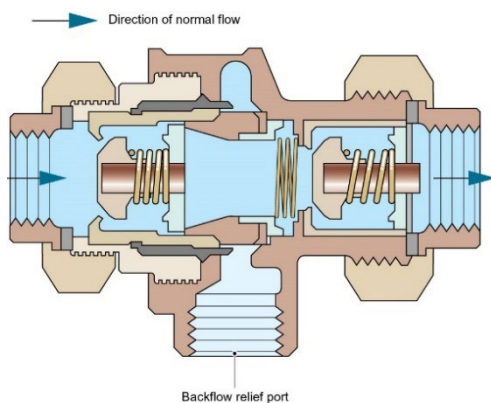

'Type DA – Anti-vacuum valve (or vacuum breaker)' means a mechanical backflow prevention device with an air inlet which is closed when water within the device is at or above atmospheric pressure but which opens to admit air if a vacuum occurs at the inlet to the device.

Type DA have no control valves on the outlet of the device and be fitted on a 300 mm minimum Type A upstand.

Fluid category rating	
Back Pressure	Back Siphonage
X	3

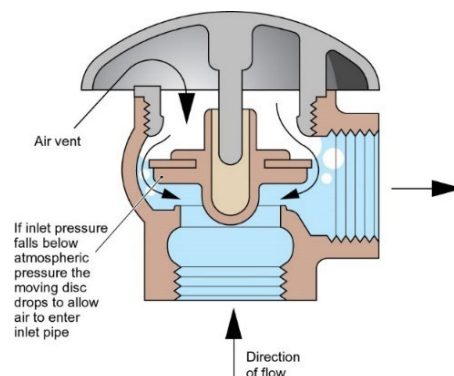
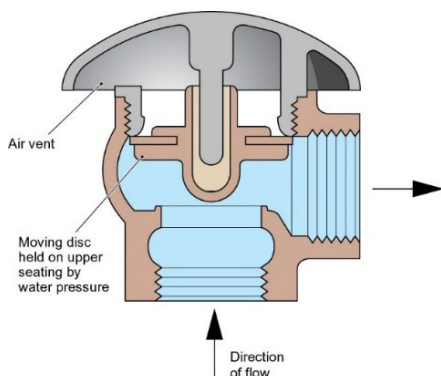

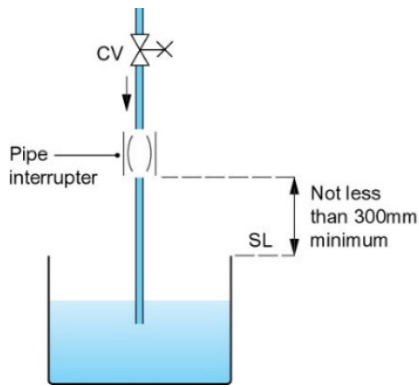

'Type DB – Pipe interrupter with atmospheric vent and moving element' means a mechanical backflow prevention device with an air inlet closed by a moving element when the device is in normal use but which opens and admits air if the water pressure upstream of the device falls to atmospheric pressure, the device being installed so that the flow of water is in a vertical, downward direction.

Arrangements incorporating a Type DB device shall have no control valves on the outlet of the device. The device shall be fitted not less than 300 mm above the spillover level of an appliance and discharge vertically downwards

Fluid category rating	
Back Pressure	Back Siphonage
X	4

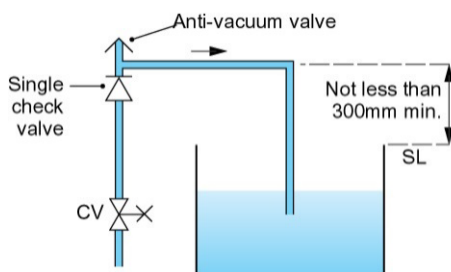
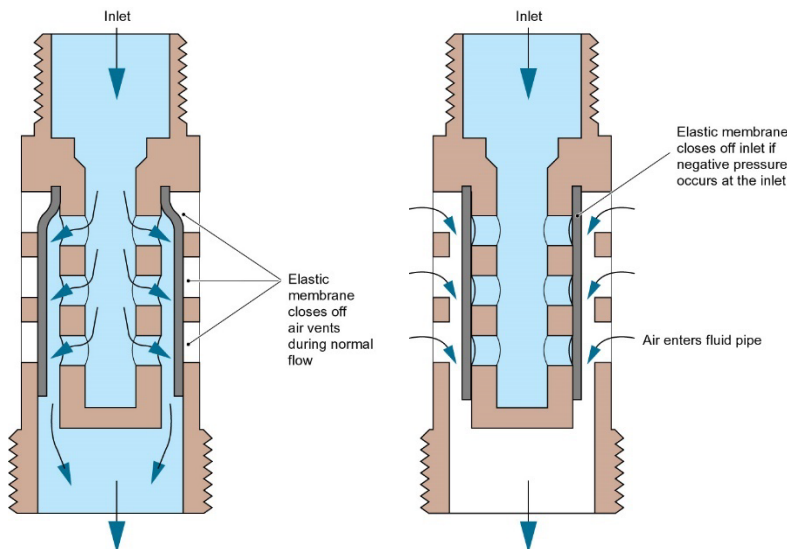

'Type DUK1 – Anti-vacuum valve combined with a single check valve' means a mechanical backflow prevention device comprising an anti-vacuum valve with a single check valve located upstream.

Type DUK1 shall have no control valves on the outlet of the device and be fitted on a 300 mm minimum Type A upstand.

Fluid category rating	
Back Pressure	Back Siphonage
2	3

'Type EA – Verifiable single check valve' means a verifiable mechanical backflow prevention device which will permit water to flow from upstream to downstream but not in the reverse direction.

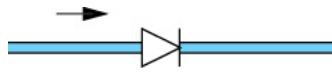

'Type EB – Non-verifiable single check valve' means a non-verifiable mechanical backflow prevention device which will permit water to flow from upstream to downstream but not in the reverse direction.

Fluid category rating	
Back Pressure	Back Siphonage
2	2

'Type EC – Verifiable double check valve' means a verifiable mechanical backflow prevention device consisting of two verifiable single check valves in series, which will permit water to flow from upstream to downstream but not in the reverse direction.



'Type ED – Non-verifiable double check valve' means a non-verifiable mechanical backflow prevention device consisting of two single check valves in series, which will permit water to flow from upstream to downstream but not in the reverse direction.

Fluid category rating	
Back Pressure	Back Siphonage
3	3

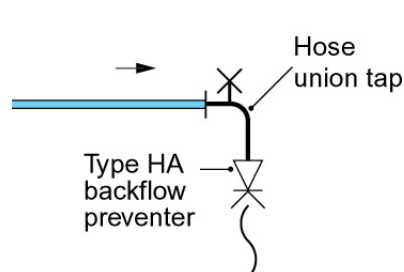
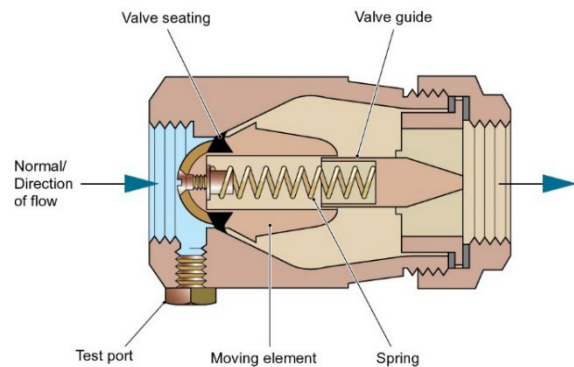
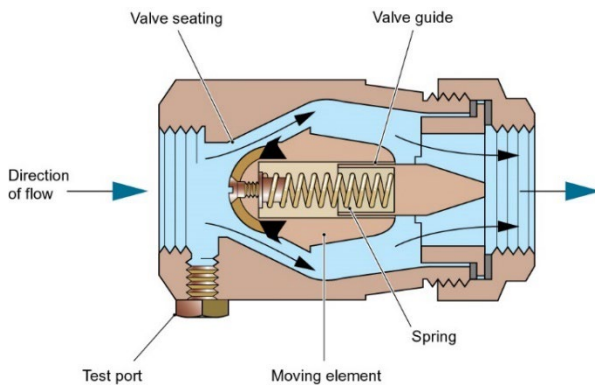

'Type HA – Hose union backflow preventer' means a mechanical backflow prevention device for fitting to the outlet of a hose union tap and consisting of a single check valve with air inlets that open if the flow of water ceases.

Fluid category rating	
Back Pressure	Back Siphonage
2	3

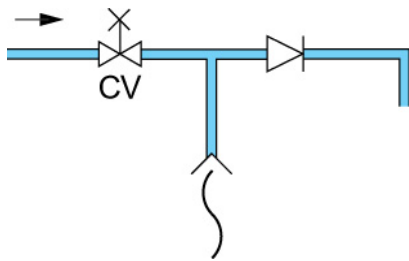

'Type HC – Diverter with automatic return' means a mechanical backflow prevention device used in bath/shower combination tap assemblies which automatically returns the bath outlet open to atmosphere if a vacuum occurs at the inlet to the device.

Fluid category rating	
Back Pressure	Back Siphonage
X	3

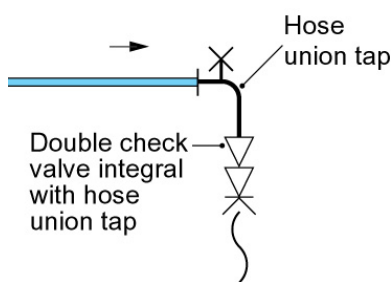

'Type HUK1 – Hose union tap incorporating a double check valve' means a hose union tap in which a verifiable double check valve has been incorporated into either the inlet or outlet of the tap.

Fluid category rating	
Back Pressure	Back Siphonage
3	3

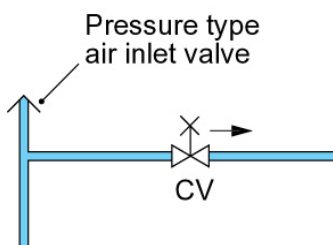

'Type LA – Pressurised air inlet valve' means an anti-vacuum valve or vacuum breaker, similar to Type DA but suitable for conditions where the water pressure at the outlet of the device under normal conditions of use is greater than atmospheric.

Fluid category rating	
Back Pressure	Back Siphonage
X	2

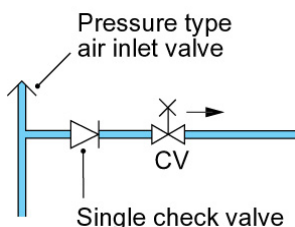

'Type LB – Pressurised air inlet valve combined with a check valve downstream' means a mechanical backflow prevention device comprising a Type LA anti-vacuum valve and a single check valve located downstream.

Fluid category rating	
Back Pressure	Back Siphonage
2	3

GL	Ground level
WC	Water closet
WB	Washbasin
SL	Spill-over level
WP	Warning/overflow pipe
SV	Stopvalve
SgV	Servicing valve
CV	Appliance control valve or tap
DT	Drain tap
T	Tundish with air gap
SCV	Single check valve
DCV	Double check valve
FC	Siphonic or non-siphonic flushing cistern
PFC	Pressure flushing cistern
FV	Pressure flushing valve
PRV	Pressure reducing valve
TRV	Temperature relief valve
TPRV	Combined temperature and pressure relief valve
EV	Expansion valve
ExVl	Expansion vessel
S	Strainer
AVV	Anti-vacuum valve
PIDC	Pipe interrupter with permanent atmospheric vent
PIDB	Pipe interrupter with atmospheric vent and moving element

